

Amantii

ELECTRIC FIREPLACES

SAFETY INFORMATION AND INSTALLATION MANUAL

**ZECL-26-2923, ZECL-30-3226,
ZECL-33-3524, ZECL-39-4134, ZECL-2939, INSERT-26-3825,
INSERT-30-4230, INSERT-33-4230**

Read these instructions completely before beginning installation. Failure to follow them could cause a heater malfunction and result in serious injury and/or property damage.

WARNING: All electric heaters have hot and arcing or sparking parts inside. Do not use it in areas where gasoline, paint or flammable liquids are stored.

WARNING: This heater is tested and listed for use only with the optional accessories listed in these instructions. Use of optional accessories not specifically tested for this heater could void the heater warranty and/or result in a safety hazard.



Keep this manual for future reference.

SAFETY INFORMATION

Due to high temperatures, the fireplace should be located out of traffic and away from furniture and draperies.

Do not place clothing or other flammable material on or near the fireplace. Never place any objects on the fireplace.

The fireplace can become very hot when running. Keep children and adults away from hot surfaces to avoid burns or clothing ignition. The fireplace will remain hot for a time after shutdown. Allow surfaces to cool before touching.

When using electrical heaters, basic precautions, like the ones listed below, should always be followed in order to reduce the risk of fire, electric shock and injury.

1. Read all instructions before using this heater.
2. Keep combustible materials, such as furniture, pillows, bedding, papers, clothes and curtains at least 3 feet from the front of the heater; keep them away from sides and rear as well.
3. Always unplug heater when it's not in use.
4. Do not operate the fireplace if it has a damaged cord or plug, after it has malfunctioned, or if the unit has been dropped or damaged in any way.
5. Do not use the heater outdoors.
6. This heater is not intended for use in bathrooms, laundry areas and similar indoor locations. Never place the heater where it may fall into a bathtub or other water containers.
7. Do not run the cord under carpeting. Do not cover the cord with throw rugs, runners or anything else. Arrange the cord away from traffic areas where it could not be tripped over.
8. To disconnect the heater, turn the controls to "OFF" before removing the plug from the outlet.
9. Do not insert or allow foreign objects to enter any ventilation or exhaust opening, as this may cause an electric shock, fire or damage to the heater.
10. To prevent a possible fire, do not block air intakes in any manner.
11. A heater has hot and arcing or sparking parts inside. Do not use it in areas where gasoline, paint or flammable liquids are used or stored.
12. Use this heater only as described in this manual. Any other use not recommended by the manufacturer may cause fire, electric shock or injury to persons.

13. Avoid the use of an extension cord because the extension cord may overheat and cause a fire. If you have to use an extension cord, the cord should be No. 14 AWG minimum size and rated not less than 1875 WATTS.

14. Always use properly grounded fused and polarized outlets.

15. Always use ground fault protection where it is required by electrical codes.

16. Always disconnect the power before performing any cleaning, maintenance or relocation of the heater.

17. To prevent a possible fire, do not burn wood or other materials in this heater.

18 To prevent electric shock or fire, always use a certified electrician, should new circuits or outlets be required.

19. When transporting or storing the heater, keep it in a dry place, free from excessive vibration.

LISTING APPROVALS

This heater has been tested in accordance with the CSA Standards for fixed and location-dedicated electric room heaters in the United States. All components are UL or CSA safety certified.

Voltage/Hz	120VAC,60Hz
Watts:	1500Watts
Amps:	15Amps Grounded Circuit

Note: This heater must be electrically wired and grounded in accordance with local codes or, in the absence of local codes, with National Electric Code.

PRODUCT DIMENSION

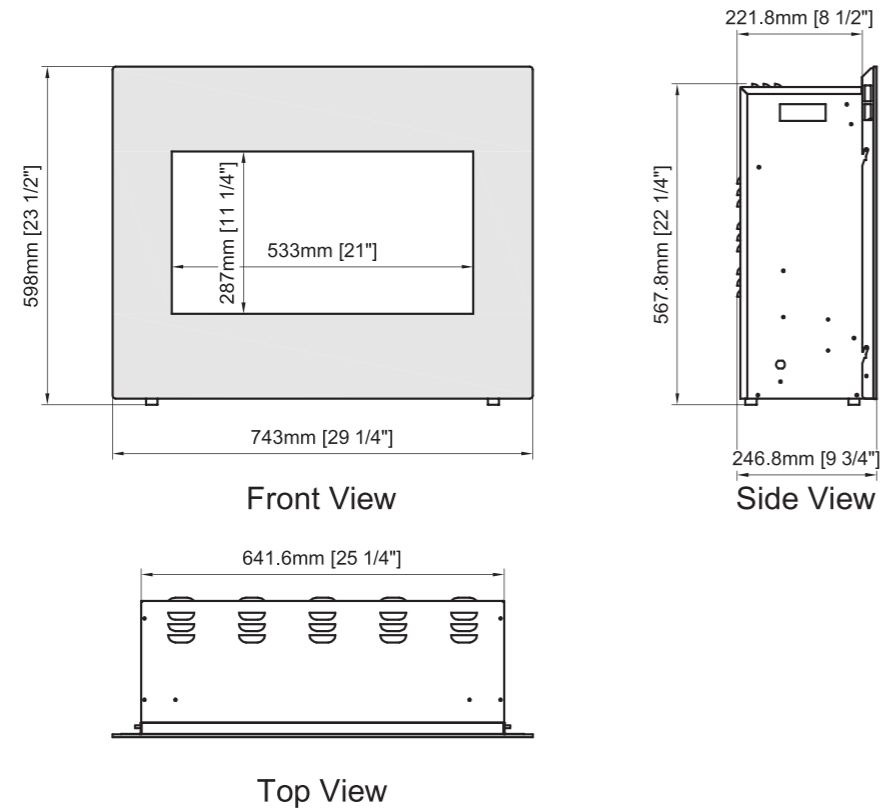

Figure 1 ZECL-26-2923 dimensions

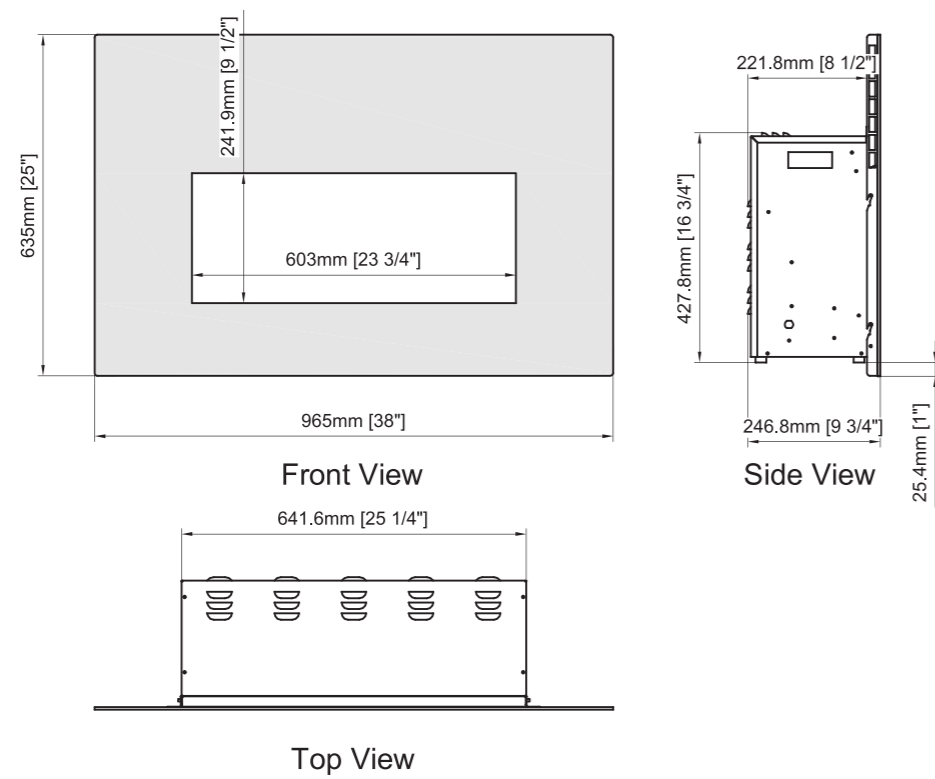

Figure 2 INSERT-26-3825 dimensions

Amantii
ELECTRIC FIREPLACES
www.amantii.com

Date of Purchase:

Dealer Information:

WARRANTY

Amantii Imports Corp. ("Amantii") warrants that your newly purchased Amantii electric fireplace is free from manufacturing and material defects for a period of one (1) year from the date of the first purchase, subject to the conditions and limitations contained below.

Warranty Application & Exclusions

This limited warranty applies to your newly purchased Amantii electric fireplace; the limited warranty's application is limited to purchases made in any province of Canada or in any of the 52 States of the United States of America, including the District of Columbia. Only the original purchaser of the product is eligible for coverage under this limited warranty; the warranty is not transferable.

Products excluded from this limited warranty

Light bulbs are not covered by this limited warranty and are the sole responsibility of the owner/purchaser.

Warranty Coverage and Term

Products covered by this limited warranty have been tested and inspected prior to shipment and, subject to the provisions of this warranty, Amantii warrants such products to be free from defects in material and workmanship for a period of one (1) year from the date of the first purchase of such products.

The limited one (1) year warranty period for products also applies to any implied warranties that may exist under applicable law. Some jurisdictions do not allow limitations on how long an implied warranty lasts, so the above limitation may not apply to the purchaser.

All other warranties—expressed or implied—with respect to the product, its components and accessories or any obligation/liabilities on the part of Amantii are hereby expressly excluded.

Limitations to Coverage Under Limited Warranty

This limited warranty does not apply to products that have been repaired, except by Amantii or its authorized service representatives, or otherwise altered. This limited warranty further does not apply to defects resulting from misuse, abuse, accident, neglect, incorrect installation, improper maintenance or handling, or operation with an incorrect power source.

Products made by other manufacturers, sold with the product or thereafter, are not covered by this limited warranty. The use of unauthorized components will render this warranty null and void.

Service Under Limited Warranty

Defects must be brought to the attention of Amantii Technical Service by contacting Amantii at (1-888-406-8764), or at 1503 – 7088 18th Avenue, Burnaby, British Columbia, Canada, V3N 0A2. Please have your proof of purchase, catalogue/model and serial numbers available when calling; any and all service under the limited warranty requires a proof of purchase of the product.

Defects

Should a product or part covered by this limited warranty be proven to be defective, in material or workmanship, and during the one (1) year limited warranty period, Amantii will replace such defective product or part without charge. If Amantii is unable to replace such product, or if replacement is not commercially practicable or cannot be timely done, in its sole discretion Amantii may, in lieu of replacement, choose to refund the purchase price for such product or part.

Limitations

In no event will Amantii, including without limitation any of its directors, officers, shareholders, employees, consultants, agents, heirs, executors, administrators and assigns, be liable to the purchaser or any third party, whether in contract, in tort, or on any other basis for any indirect, special, punitive, exemplary, consequential, or incidental loss, cost or damage arising out of or in connection with the sale, maintenance, use or inability to use the product, even if Amantii, including without limitation any of its directors, officers, shareholders, employees, consultants, agents, heirs, executors, administrators and assigns, have been advised of the possibility of such losses, costs or damages, or if such losses, costs or damages are foreseeable. In no event will Amantii, including without limitation any of its directors, officers, shareholders, employees, consultants, agents, heirs, executors, administrators and assigns, be liable for any direct losses, costs or damages that exceed the purchase price of the product.

Some jurisdictions do not allow the exclusion or limitation of incidental or consequential damages, so the above limitation or exclusion may not apply to the purchaser.

Application of Provincial and State Law

This limited warranty gives you specific legal rights, and you may also have other rights which vary from jurisdiction to jurisdiction. The provisions of the United Nations Convention on Contracts for the Sale of Goods shall not apply to this limited warranty or the sale of products covered by this limited warranty.

General

Amantii reserves the right to make changes at any time without notice, in design, material, specifications, prices and the right to discontinue styles and products.

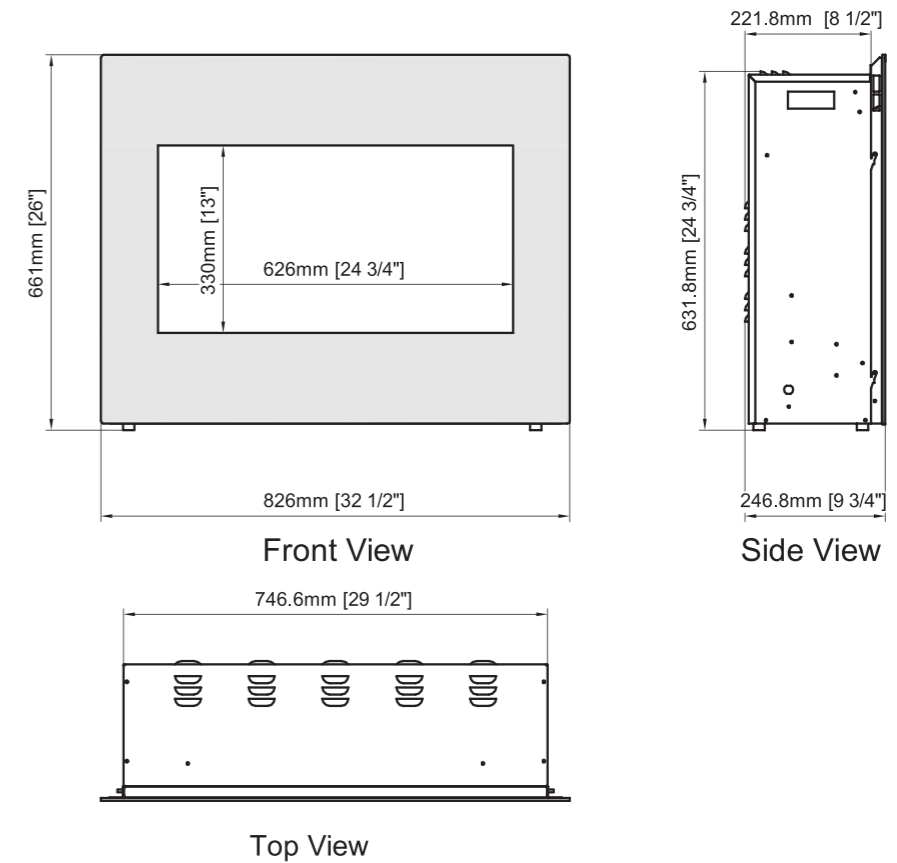

Figure 3 ZECL-30-3226 dimensions

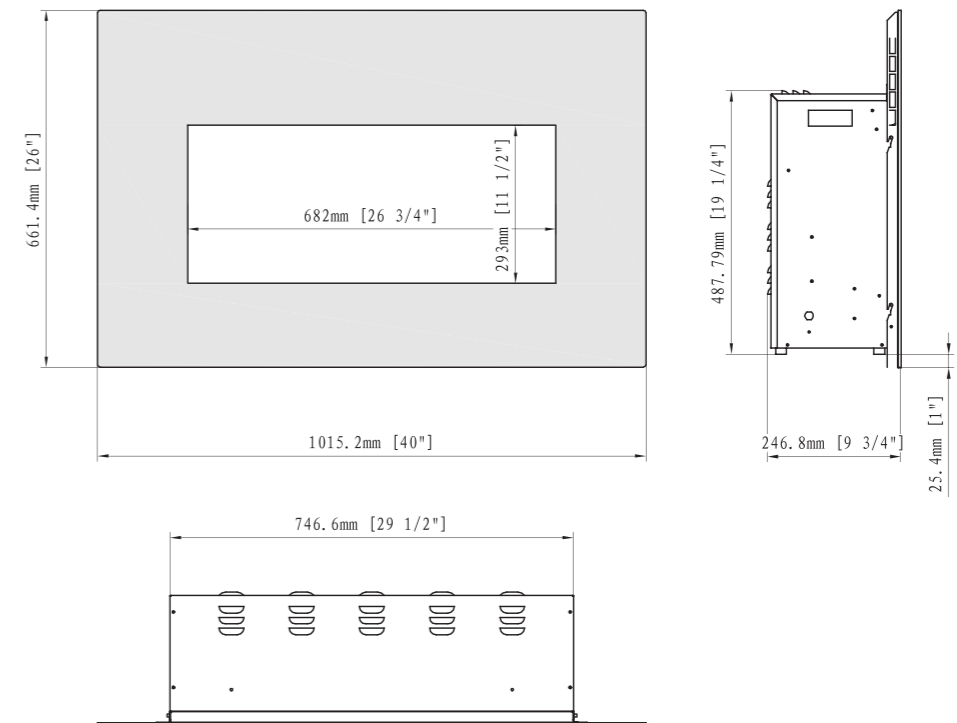

Figure 4 INSERT-30-4230 dimensions

TROUBLE SHOOTING

⚠ WARNING: Turn off the appliance and let it cool before servicing it. Only a qualified service person should service and repair the heater.

OBSERVED PROBLEM	POSSIBLE CAUSE	REMEDY
Fireplace turns off and will not turn on	Fireplace has overheated and safety device has caused thermal switch to disconnect or home circuit breaker has opened	Reset switch by turning main power switch off and waiting five minutes, then turning it back on
Log set and/or ember is dark	Wiring is loose	Inspect wiring for loose connections and repair or replace if necessary
Flame is not moving	Flame motor is defective	Call a qualified service technician
Remote control does not work	Low Batteries Power switch is in OFF position	Replace AA batteries in remote control Turn on the main power switch
Heater does not provide heat when turned on	Thermal switch has been tripped. Circuit breaker has been tripped	Turn the unit off and unplug the unit for five minutes. Plug back in and turn the unit on. If plug can not be reached, follow directions for tripped circuit breaker Turn off circuit breaker that supplies electricity to the unit .Wait five minutes then flip circuit breaker back on.

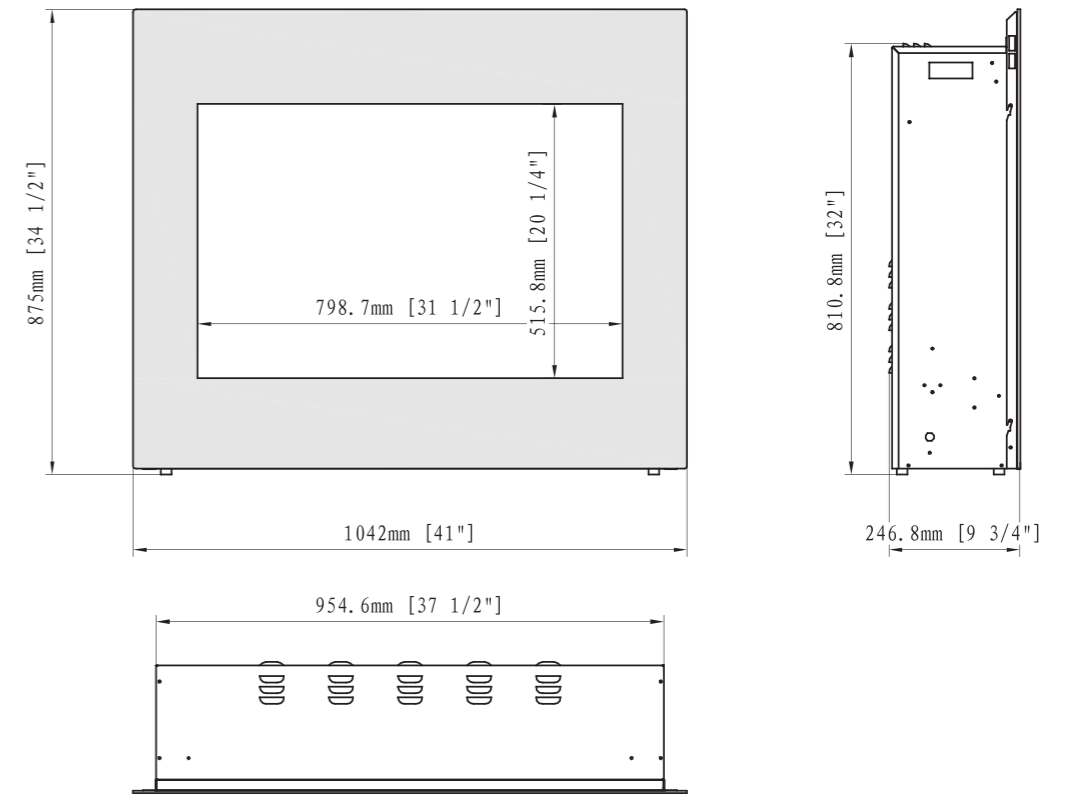

Figure7 ZECL-39-4134 dimensions

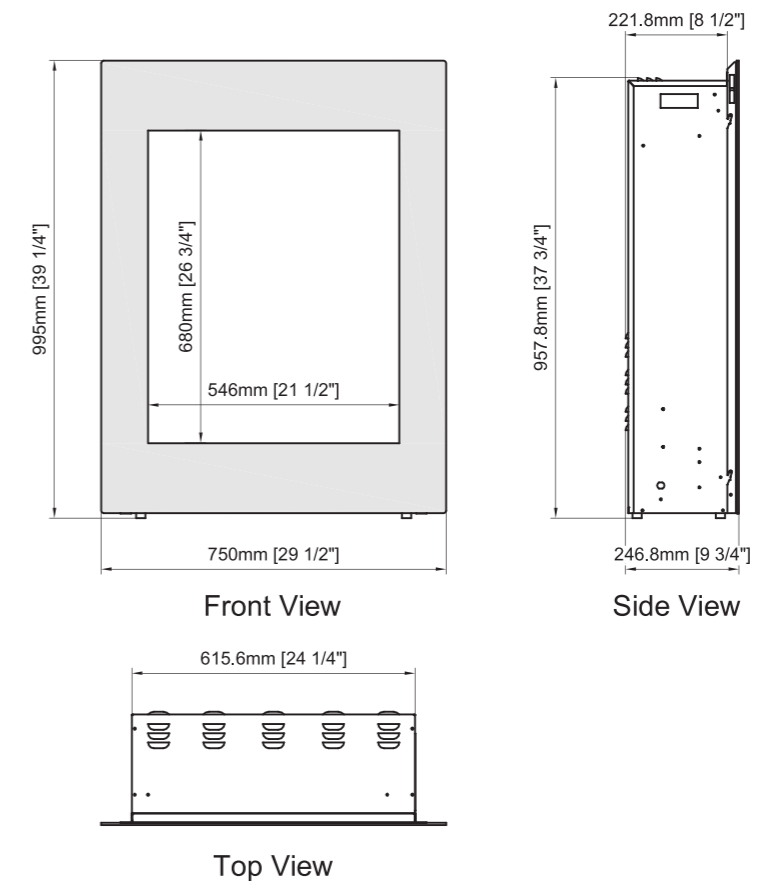

Figure8 ZECL-2939 dimensions

Locating FIREPLACE

⚠️WARNING: Never locate this heater where it may fall into a bathtub or any water container.

NOTICE: Minimum and maximum clearances must be maintained at all times. Illustrations throughout these instructions reflect typical installations and are for design purposes only. Actual installations may vary slightly due to individual preferences.

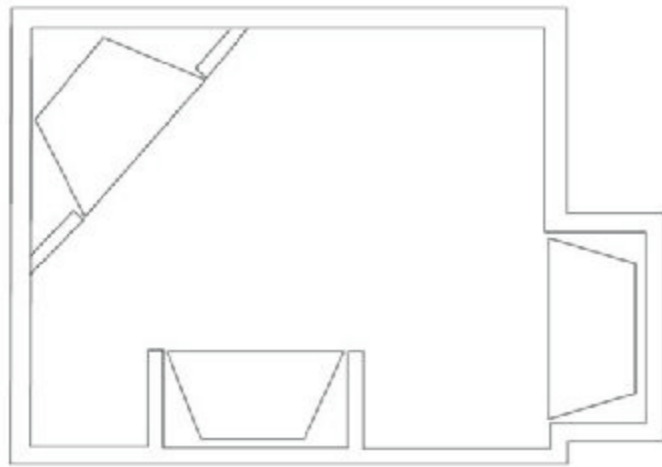

Figure 9 - Heater Locations

Figure 8 illustrates a variety of ways the heater may be located in a room. The heater may be installed directly on the floor, carpet or raised on a hearth.

WARNING: RISK OF FIRE. MAINTAIN ALL SPECIFIED AIR SPACE CLEARANCES TO COMBUSTIBLES. FAILURE TO COMPLY WITH THESE INSTRUCTIONS MAY CAUSE A FIRE OR CAUSE THE APPLIANCE TO OVERHEAT. ENSURE ALL CLEARANCES (I.E. BACK, SIDE, TOP, VENT MANTEL, FRONT, ETC.) ARE CLEARLY MAINTAINED. APPLIANCE VENTS LOCATED ON THE FRONT AND BACK OF THIS ELECTRIC APPLIANCE CANNOT IN ANY WAY BE COVERED AS IT MAY CREATE A FIRE HAZARD. WHEN USING PAINT OR LACQUER TO FINISH THE MANTEL, THE PAINT OR LACQUER MUST BE HEAT RESISTANT TO PREVENT DISCOLOURATION.

⚠️WARNING: Before undertaking maintenance or replacing the light bulb(s) or interchanging the reflection panel(s) always disconnect the heater from the electricity supply by removing the 3 pin plug and allowing the heater to cool.

NOTICE: This remote control must remain within 26 ft. (8 m) of the fireplace to be effective.

NOTICE: Do not mix old and new batteries.

Note: Make sure your batteries are fully charged and installed correctly in your remote control.

CLEANING AND MAINTENANCE

⚠️WARNING: Always disconnect the power and allow the heater to cool before performing any cleaning, maintenance or relocation. Turn the controls to OFF and remove the plug from the outlet or turn off the circuit breaker before attempting any cleaning.

FRONT GLASS

1. The glass is cleaned in the factory during assembly. During shipment, installation, handling, etc. the glass surface may collect dust particles. These can be removed by buffing lightly with a clean dry cloth.
2. To remove fingerprints or other marks, the glass can be cleaned with a damp cloth using a good quality household glass cleaner. The glass should be completely dried with a lint free cloth or paper towel.
3. In the event of glass breakage, vacuum all remaining glass pieces with a shop vac. **DO NOT VACUUM WHILE THE PIECES ARE HOT.** Replace glass only with replacement parts made specifically for this heater. Never substitute material. Only fully tempered soda lime safety glass may be used on this heater.

Note. The heating and flame function can only be operated by the remote control.

The remote control needs 2 pcs AA batteries (not included).

Note: When the heater is turned on for the first time, it may release a slight, harmless odor. This odor is a normal occurrence caused by the initial heating of the internal heating elements and should not occur after the initial burn off. (This odor may occur again if dust or debris has been trapped in the unit.)

3. After assembly, you can use the remote control to operate the fireplace.

4. When using remote control, always point it at the electric fire, and keep no far away than 6 metres.

5. The  button located at the top position of the remote control is On/off , press it, the flame and ember will be on. The heater will be off. Press again, it will stop working.

6. The "DISPLAY ON OFF": Press on it, the flame and ember will be off, press again, the flame and ember will be on.

7. The EMBER+/- buttons: control the brightness of ember , totally 6 settings..

To increase the ember brightness press the ember(+) button, each press will increase a little of brightness until the biggest brightness, totally 2 settings. after that even more press, the brightness will no change.

To decrease the ember brightness press the ember(-) button, each press will decrease a little of brightness until the light is off, totally 3 settings.

8. Heater On/off button: press the heater button, Heater work at the high mode(1500W)

press the Heater Button once, the heater will stop heating.

HIGH heater works at 1500w

LOW heater works at 750w

TEMP Press this button, the heater will automatically control the room temperature between approximately 22-25 °C, it will shut off when room reaches approximately 25°C, and will automatically heat when room reaches approximately 22°C,

9. The Flame Intensity +/- buttons: control the brightness of flame intensity, totally 5 settings.

To increase the flame effect: press the flame(+) button, each press will increase a little of flame, until the biggest flame, totally 2 settings. after that even more press, the flame will no change.

To decrease the flame effect: press the flame(-) button, each press will decrease a little of flame, until flame is off, totally 2 settings.

Notice: To work the remote control must be within about 6 metres of the fireplace and not too far off to either side.

Important! If the flame does not activate after the POWER ON/OFF button is pressed, press the DISPLAY ON/OFF button to activate the flame. If the flame does not appear, repeat steps as above

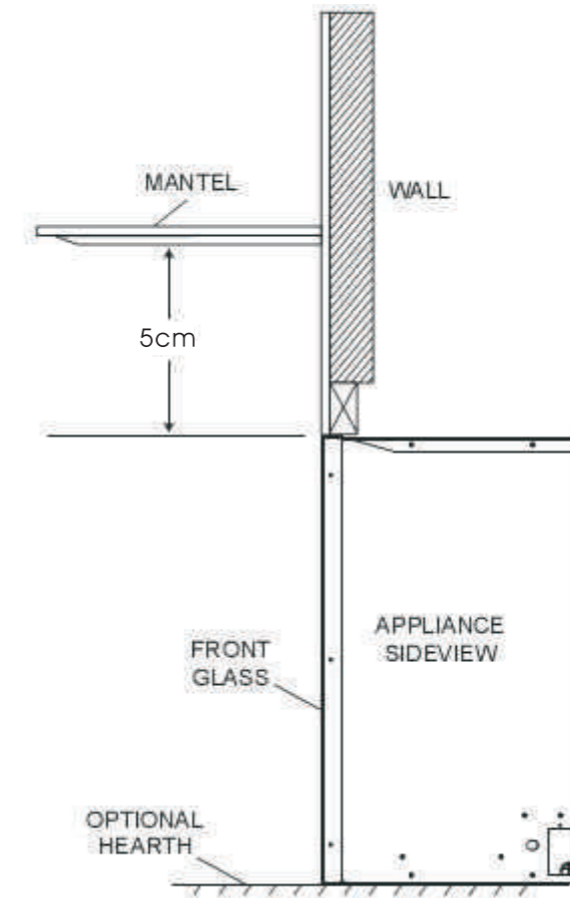

Figure 10

The minimum distance from the top of the appliance that the mantel can be installed is 5cm ,at any depth.

The sides and back are 1cm.

UNPACKING AND TESTING FIREPLACE

Carefully remove the unit from the box. Prior to permanently installing the unit, test it to make sure it operates properly. To do this, plug the unit's power supply cord into a 120-volt grounded outlet.

INSTALLATION

⚠ CAUTION: The unit's power supply cord must be connected to a properly grounded and protected 120-volt outlet. Always use ground fault protection where required by the electrical code.

⚠ WARNING - RISK OF FIRE! To prevent a possible fire, do not block the air intake or exhaust in any manner.

⚠ WARNING - RISK OF FIRE! The power cord must not be pinched or placed against a sharp edge. Secure the cord to avoid tripping or snagging thus reducing the risk of fire, electric shock or personal injury. Do not run the cord under carpeting. Do not cover the cord with throw rugs, runners or similar items. Arrange the cord away from traffic areas where it could be tripped over.

Once the mantel has been prepared, the fireplace can be installed.

Select a suitable location that is not susceptible to moisture and is away from drapes, furniture and high traffic areas.

Note: Follow all national and local electrical codes. This insert can be installed into an existing mantle or as a new construction.

1. Unplug the unit and turn the power switch to the "ON" position.
2. Push the fireplace into the mantel.
3. Plug the fireplace into a 15amp/120V, grounded outlet.

Note: Unscrew and remove the screws on both sides of the unit before you place the fireplace into the mantel.

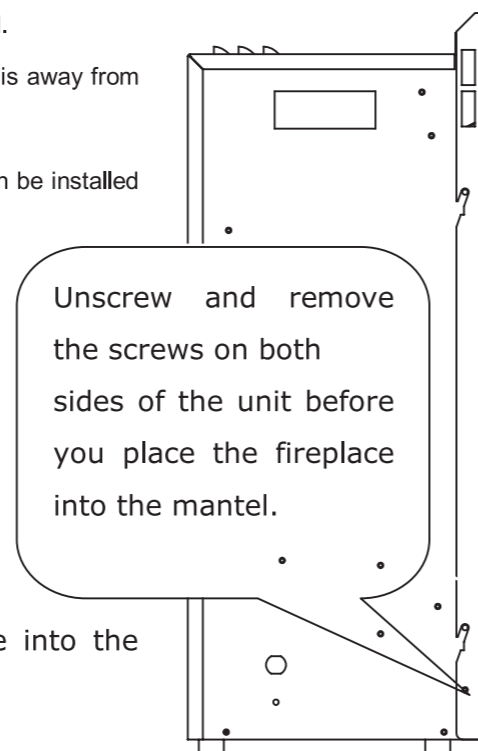

Figure 11 –The location of screw

OPERATING INSTRUCTIONS

The power switch is located behind the glass panel .

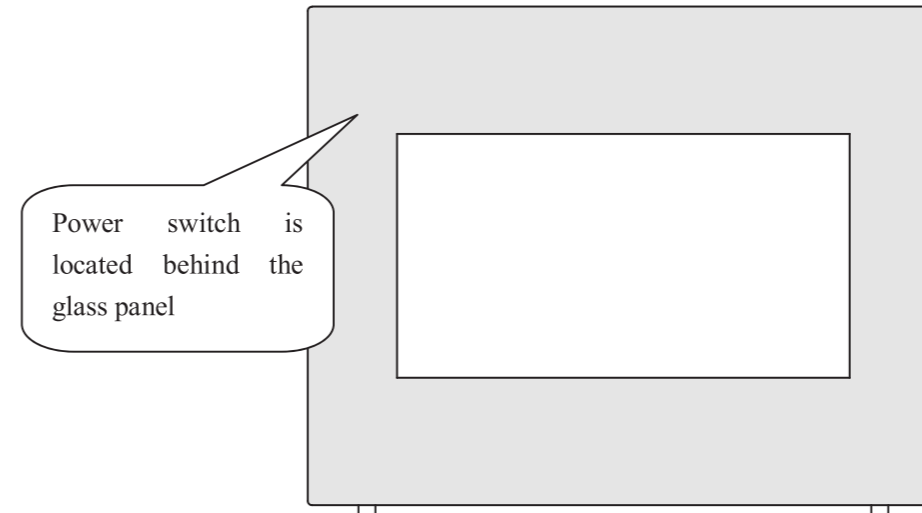

Figure 12 –The location of power switch

1. Plug in your electric fireplace.
2. Push the main "ON/OFF" power switch to "I" to turn on the power. The "I" indicates ON and "O" indicates OFF. When the unit is turned on, the Power Led will be red .

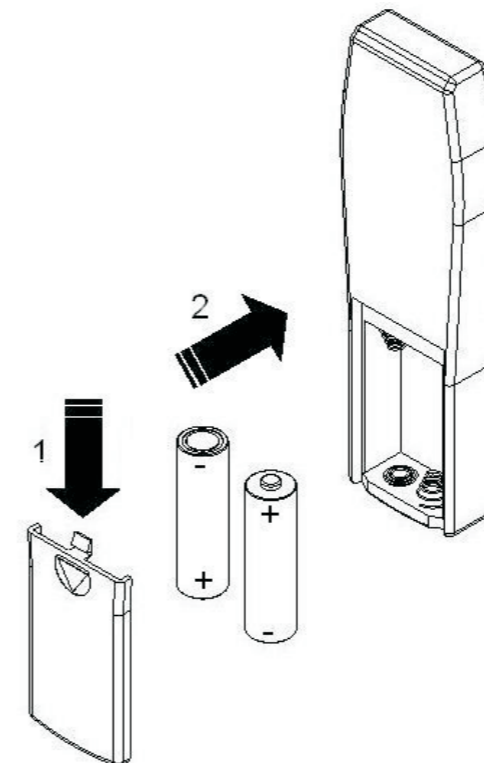

Figure 13

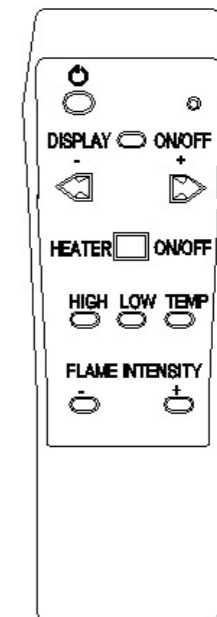

Figure 14